

MANUAL

TM

Housing & Low Rise Multi Residential

Technical & Installation Manual

The Liminal Technical and Installation Manual has been created as a source of information to provide general guidance to consultants – and does not replace the services of a professional consultant and/or relevant engineers designing the project.

It is the responsibility of the architectural designer and engineering parties to ensure that the details in the Liminal Technical and Installation Manual are suitable for the intended project.

The recommendations of this guide are formulated along the lines of good building practice, but are not intended to be an exhaustive statement of all relevant data.

Contents

- 1 Why Liminal?
- 2 Structural, Fire, Acoustic & Thermal
- 3 Panel Specification
- 4 Panel Installation

Why Liminal wall systems are creating a better way to build

From the homeowner to the builder, architect, designer, installer or developer, the Liminal Wall System has been designed to deliver advantages of thermal, sound, fire, quality, durability and speed of installation to the Australian construction industry.

Liminal Wall is a new and innovative high performance external wall system that is a high-quality slender cement extruded Panel.

Seeking to provide a cost effective external wall solution for domestic housing and Low-Rise Multi Residential construction markets.

Architectural Considerations

The look and feel of the external façade for housing and multi residential developments is important to create that emotional and quality attachment to the value of the development. On entry, owners expect a wow factor as their first impression.

Liminal Wall Systems offer a high quality pre-finished surface ready for paint. The panel consists of an "A" and "B" face. The "A" face is the finished face of the panel that presents outwards.

National Construction Code (NCC) compliance

Material properties and the structural capacity of the Liminal Wall Panels were tested and passed in approved laboratories to International Standards ISO9001.

The fire performance for the Liminal Wall Panel has been completed and passed to AS1530.1.

Benefits and Savings

The Liminal panel offers simplicity of construction and savings. The wall systems strengths and advantages are the exceptional quality and performance of their 35mm and 50mm cement extruded panels. All panels are sanded in their finished process providing an ultra-smooth and flat surface. Depending on your project requirements, once the panels are installed and set, the panel installation process is completed and ready for painting.

Liminal Panels require **no render** improving speed and cost of installation

Design Considerations

Liminal panel is available in standard sizes and widths of 600mm allowing for designers to take advantage of modular construction in the design stage.

The full benefits in cost and time are maximised when the construction is designed in 600mm and 300mm modules. This will reduce onsite cutting and unnecessary waste.

The Liminal wall system detailed in this design guide is for veneer construction where the Liminal panel is fixed to structural studs and top hats.

Designing either a single house or a multi residential project there are 4 key performance requirements that must be designed to and satisfied to comply to the National Construction Code (NCC). These Key performance requirements are, Structural, Fire, Acoustic and Thermal.

Structural, Fire, Acoustic & Thermal

Structural

For the design of the structural frame and supporting top hats that require a minimum of .55 BMT, you must determine the wind loads for the project. Wind loads determine the structural requirements for the structural frame, this is the responsibility of the engineer and framing manufacturer.

The next step in the design is calculating the number of top hats to secure the Liminal panel to the top hats and the number of screws to secure the panel to the top hats. Consideration must be taken for not only the wind pressure on the wall but also for the increase wind pressures on the corners including suction.

The following table is a guide for the number of top hats based on the structural frame stud locations for the wind categories. This table is for ground floor construction where the panel weight is bearing on the concrete slab and second floor construction that requires additional detailing as the structural frame will be carrying all the weight of the panels as the panels will not be bearing on the lower floor panel.

Consideration is required for additional top hats to carry the free weight of the panel on the structural frame. Set out below is a table to guide designers for the design of the top hat spacings considering the wind loads.

We recommend your structural engineer reviews and certifies all the calculations, as this table is a guide only.

Liminal Wall top hat table for panel lengths

GROUND FLOOR CONSTRUCTION

Wind Category	Stud spacing	≤ 2400		≤ 2700		≤ 3000	
		Typical	Corner	Typical	Corner	Typical	Corner
N2	600	3	3	3	3	4	4
N3	600	3	4	3	4	4	4
N3, C1	450	3	3	3	3	4	4
N4, C2	450	3	4	3	5	4	5
N5, C3	450	4	4	5	5	5	5

SECOND FLOOR

Wind Category	Stud spacing	≤ 2400		≤ 2700		≤ 3000	
		Typical	Corner	Typical	Corner	Typical	Corner
N2	600	4	4	4	4	4	4
N3	600	4	4	4	4	4	4
N3, C1	450	4	4	4	4	4	4
N4, C2	450	4	4	4	4	4	5
N5, C3	450	4	5	5	6	5	6

Please note: Top hat spacing specifically for the top and bottom of the panel needs to be a maximum of 250mm. For remaining spacing refer to the above table.

In addition to the number of top hats for the structural capacity of the wall is the number of screws required to secure the panel to the top hats per location of the panel on the building.

Like the top hat table above, set out below is a table for the number of screws per panel, per top hat per location.

Liminal Wall screws per panel per location per top hat

LIMINAL WALL SCREWS PER PANEL PER LOCATION

Wind Category	Stud spacing	GROUND FLOOR				SECOND FLOOR			
		Typical Top Hat location		Corner Top Hat location		Typical Top Hat location		Corner Top Hat location	
		End	Middle	End	Middle	End	Middle	End	Middle
N2	600	2	2	2	2	2	2	2	2
N3	600	2	3	2	3	2	3	2	3
N3, C1	450	2	2	2	3	2	2	2	3
N4, C2	450	2	3	3	3	2	3	3	3
C3	450	2	3	3	4	2	3	3	4

Screws should be spaced equally across the face of the panel, i.e., 150mm from the edge of the panel. Screw type and selection are provided for screw fixing the top hats to either timber or steel studs, the fixing of the Liminal panel to the top hats, NB Fixing the Liminal panel to the top hats should NOT be changed without prior approval.

Fire

Liminal Wall panels can be subject to fire load performance, the panel is a cement extruded panel performing like concrete and is non-combustible and fire tested and accredited to AS 1530.1

When designing the external wall and their panel locations the fire code must be complied with ensuring all FRL requirements and performances are achieved. Special attention to the FRL requirements for housing in bush fire attack zones is most important. The Panels though deemed non-combustible in accordance to AS 1530.1:1997(R2016), the Wall system needs to meet the requirements of each BAL when assessed to the requirements of AS 3959: 2018. All service penetrations must meet the BAL standards AS359:2018 requirements for fire.

Acoustic

A single 35mm Liminal wall panel has been acoustically tested to AS 1191 and AS/NZS ISO 717.1 and achieved a rating of RW 29. Acoustic performances are influenced by the width of the cavity and the rating of the wall insulation, the benefit of the increase in insulation density has a dual improvement in acoustic and thermal performance. Liminal wall systems can be adjusted with the configuration for the wall to achieve excellent acoustic values. Consideration when designing for the surrounding environment is required for local council compliance.

Thermal

The thermal performance can be influenced by many factors related to the wall system design. In addition, poor construction practices can also reduce the thermal performance of the wall.

With the application of panels and modular construction will improve the thermal performance as the panels are glued together creating a greatly improved airtight barrier.

In achieving the thermal R value insulation materials can be installed in the cavity enhancing the thermal R value.

Depending on which climate zone in Australia the project is planned to be built will govern which performance insulation will be required.

Also improving the thermal performance and managing condensation is the requirement and application of applying sarking on the stud frame between the stud and the top hats. This improves the air tightness improving the combined performance values for the insulation and energy efficiencies for the wall system and building performance.

Layer	Material	Thickness (mm)	Thermal Conductivity (w/Km)	R Value (m2K)/W		R Value (m2K)/W		R Value (m2K)/W		R Value (m2K)/W
				Frame no Bulk		Frame R1.5 Bulk		Frame R2.0 Bulk		Frame R2.5 Bulk
				70mm	90mm	70mm	90mm	70mm	90mm	90mm
Layer 1	Outside Air Film (3–7m/s)	n/a	n/a	0.030	0.030	0.030	0.030	0.030	0.030	0.030
Layer 2	35mm Liminal Wall Panel	35	0.25	0.140	0.140	0.140	0.140	0.140	0.140	0.140
Layer 3	25mm Top Hat (Air Gap)	25	n/a	0.534	0.534	0.534	0.534	0.534	0.534	0.534
Layer 4	Sarking	<1mm	0	0.000	0.000	0.000	0.000	0.000	0.000	0.000
Layer 5	Frame Air Gap (Frame Size)		n/a	0.585	0.628	1.500	1.500	2.000	2.000	2.500
Layer 6	10mm Plasterboard	10	0.17	0.059	0.059	0.059	0.059	0.059	0.059	0.059
Layer 7	Internal Air Film (still air)	n/a	n/a	0.120	0.120	0.120	0.120	0.120	0.120	0.120
Total R-Value				1.468	1.511	2.383	2.383	2.883	2.883	3.383
Total R-Value (50mm Liminal Panels R-Value 0.18)				1.528	1.571	2.443	2.443	2.943	2.943	3.443

Weather protection

The panels are a physical barrier to water entry with the application of an external impervious applied coating. Applied Coatings such as paint are recommended to achieve a watertight barrier and need to be maintained in accordance with the manufacturers specification to ensure continued weatherproofing. We recommend Dulux Professional paint system or equivalent.

Technical Specification

This specification sets out the panel performances and available sizes.

Mechanical Properties		Technical Data		Section Properties		
Mechanical Properties	Minimum Performance	Properties	Performance	Section Properties	Panel thickness	
Characteristic compressive strength, f'c	>40MPa	Shrinkage	.07-.09%		35mm	50mm
		Absorption	<18%	Second Moment of Area, Ixx	184.426 x 104 mm ⁴	532.293 x 104 mm ⁴
Characteristic flexural strength, f'ct.f	14MPa	Dry Density	1800–1830 kg/m ³ at 20°C	Section Modulus, Zxx	109.402 x 103 mm ³	213.171 x 103 mm ³
Mean Modulus of Elasticity, E	15,000 MPa	Moisture Content	≤8%	Area, A	12,951 mm ²	16,783 mm ²

Panel Type

Liminal Smooth and Liminal Express

Panel Thickness	35mm				50mm			
	Panel Width	592	592	592	592	592	592	592
Panel Length	2550	2700	2800	3000	2800	3200	3500	4000
Panel m ²	1.51	1.6	1.66	1.78	1.66	1.89	2.07	2.37
Nominal Panel Mass @10% MC in kg/m ²	39	39	39	39	51	51	51	51
Number of Panels per pallet	16	16	16	16	12	12	12	12
SQM per pallet	24.16	25.6	26.56	28.48	19.92	22.68	24.84	28.44
Weight of Panel (kg)	58.89	62.40	64.74	69.42	84.66	96.39	105.57	120.87
Weight of pallet (kg)	942.24	998.4	1035.84	1110.72	1015.92	1156.68	1266.84	1450.44

Liminal Groove

Panel Thickness	50mm				
	Panel Width	500	500	500	500
Panel Length	2400	2550	2700	2800	3000
Panel m ²	1.20	1.28	1.35	1.40	1.50
Nominal Panel Mass @10% MC in kg/m ²	49	49	49	49	49
Number of Panels per pallet	12	12	12	12	12
SQM per pallet	14.40	15.30	16.20	16.80	18.00
Weight of Panel (kg)	58.80	62.72	66.15	68.60	73.50
Weight of pallet (kg)	705.60	752.64	793.80	823.20	882.00

Liminal Panels can be made to order and site specific - refer to the tables for fixing specifications. Maximum length 3m with exception of 50mm Liminal Smooth & Liminal Express maximum length 4m.

Wall System Components

- Liminal Wall Panel
- Rondo PEX10V30 Control Joint
- Wunderfixx Rapid Set
- Screws*
- Selleys Fireblock PB
- Metal Top Hat

Liminal Wall screw types for fixing locations

Fixing locations	Screw type
Top hat to timber stud	12 - 11 x 35mm type 17 Hex head
Top hat to steel stud	10 - 16 x 16mm self-drilling Hex head
35mm Panel to top hat	10 - 16 x 55mm countersunk wing tipped drill point
50mm Panel to top hat	10 - 16 x 75mm countersunk wing tipped drill point
Fixing fixtures to panel	10 - 16 x 30mm Wafer head self-drilling screw

Liminal Wall System Sheets

Liminal Smooth™

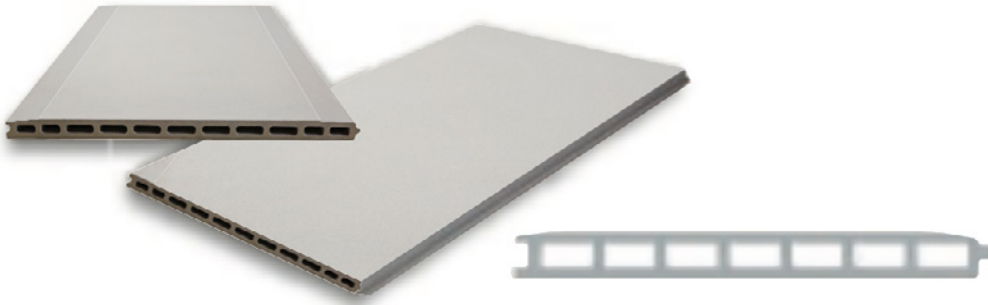

Liminal Express™

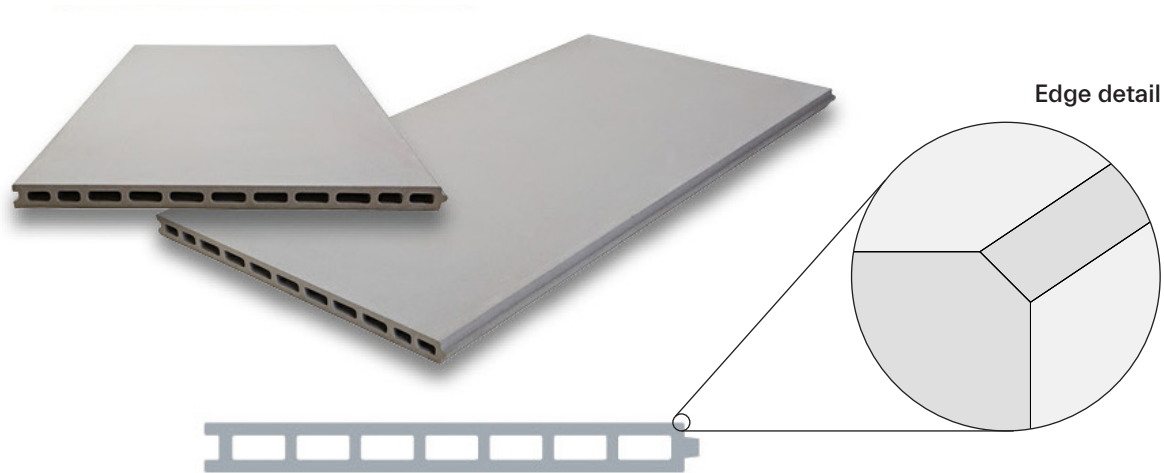

Liminal Groove™



Liminal Panel Housing Single Storey Wall

Wall systems

Ground floor level

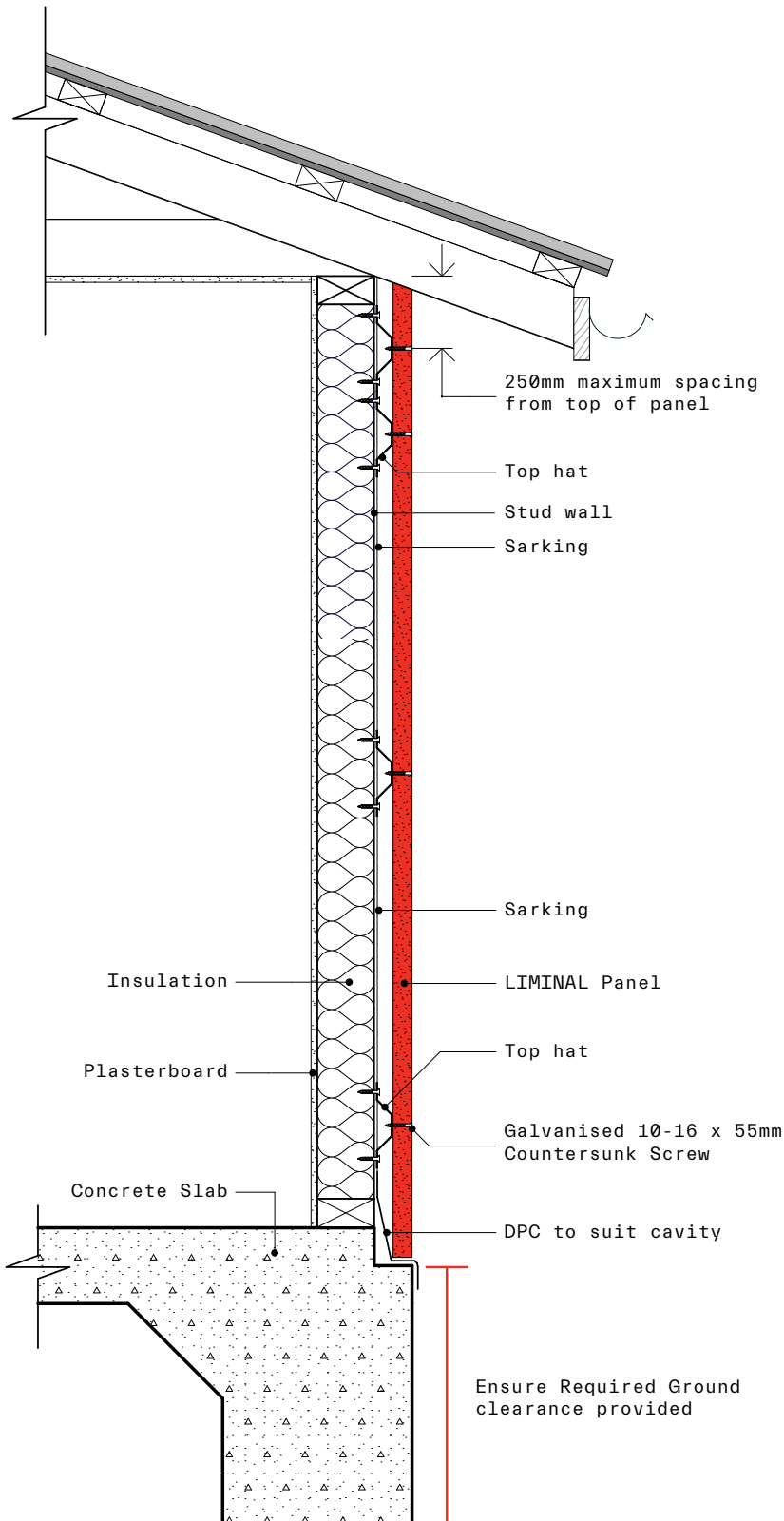

Note:
Top hat spacing to be a maximum 250mm from the top and bottom of the panel.

Liminal Panel Housing Double Storey Wall

Wall systems

Second floor level

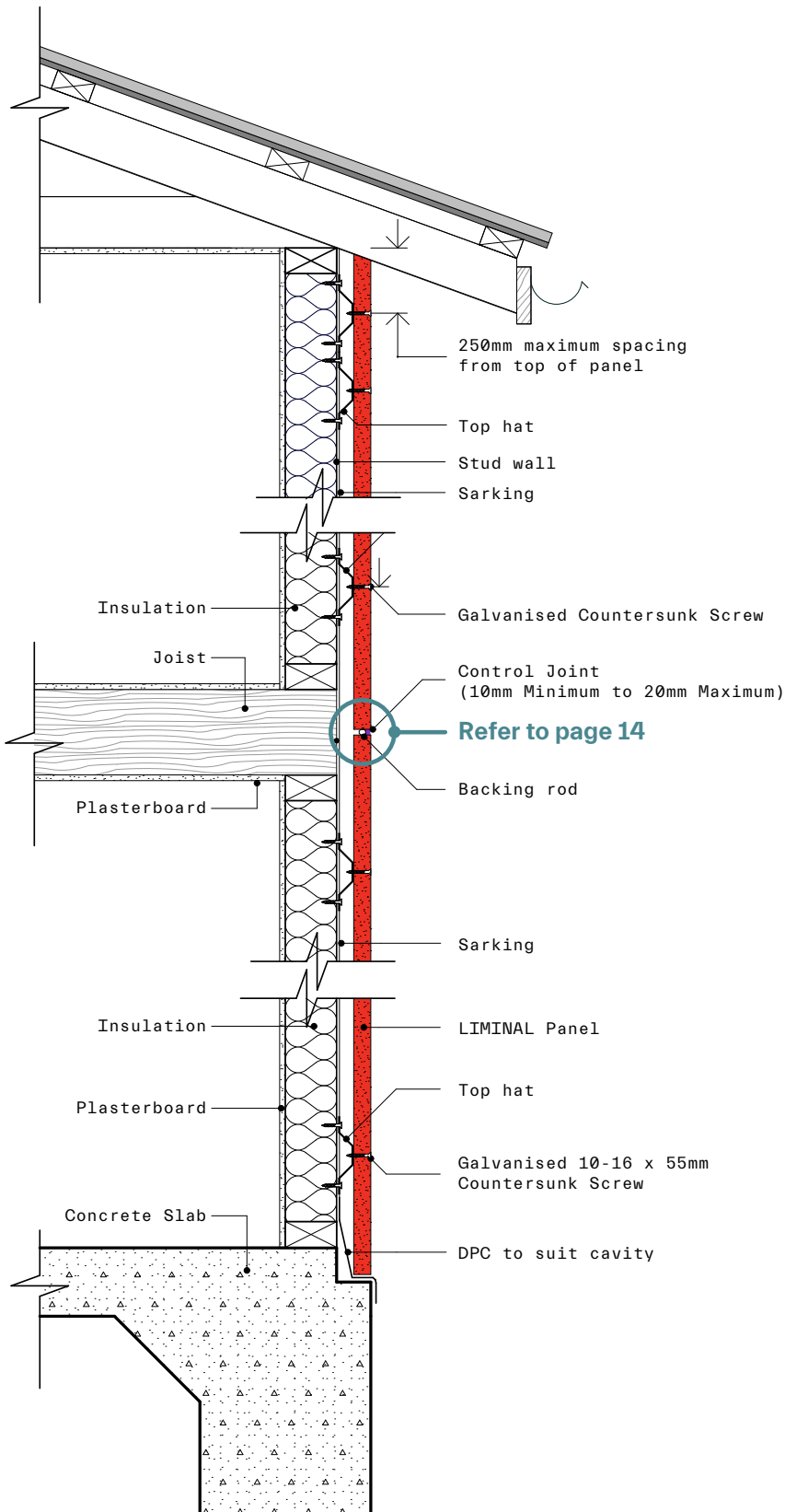

Note:

Top hat spacing to be a maximum 250mm from the top and bottom of the panel.

Liminal Panel Control Joints

Vertical Control Joint

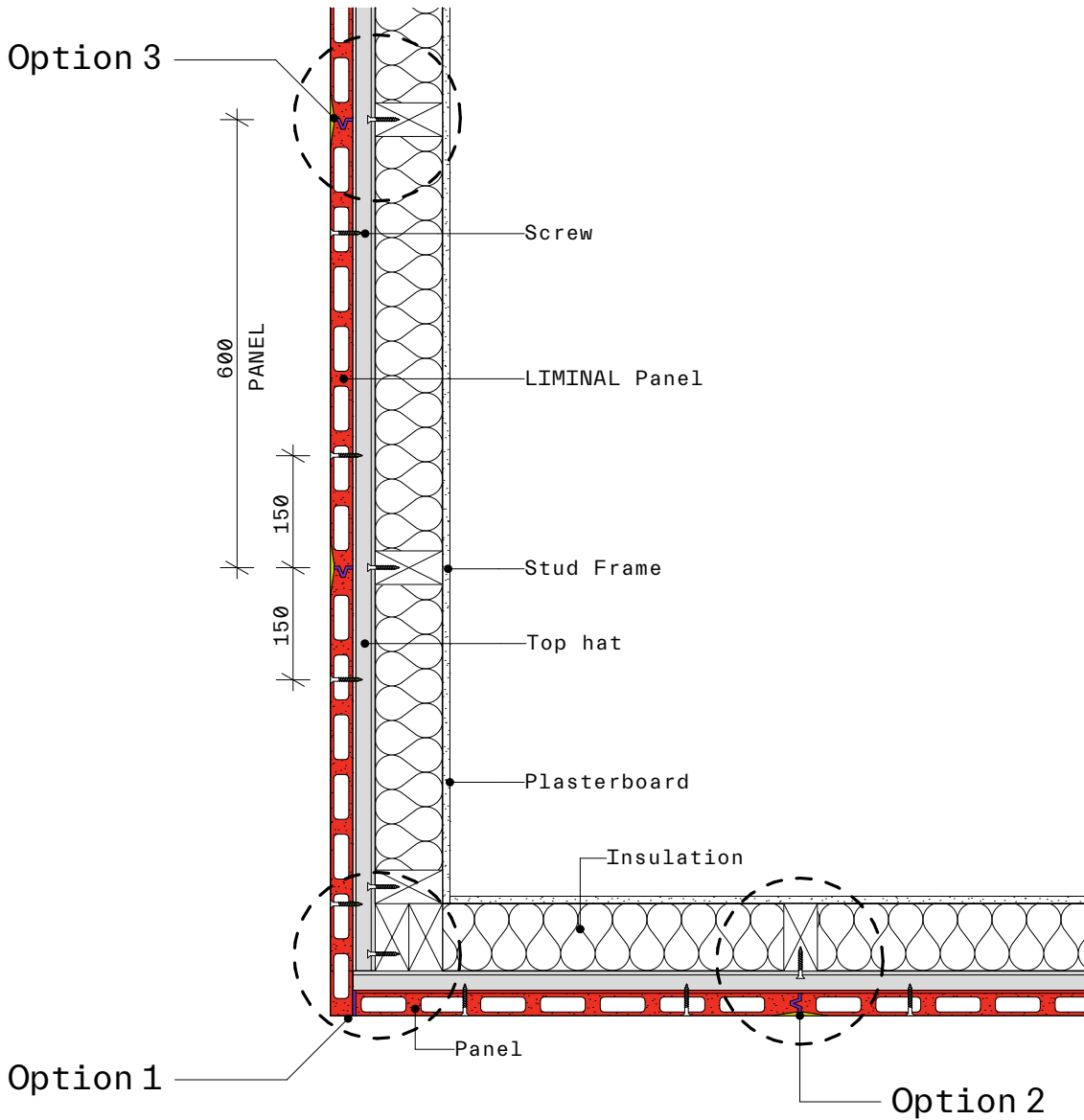

Liminal recommends control joints be located at the corners of the junction of the panels, that is set at 35mm back from the corner as detailed as Option 1. If this is not preferred, the control joint can be located at the first panel joint at 600mm Option 2, BUT the maximum spacing from a corner is 1200mm Option 3. On straight runs of walls, control joints must be installed every 6 metres

Liminal Panel Control Joints Settings

Corner Control Joint (Option 1)

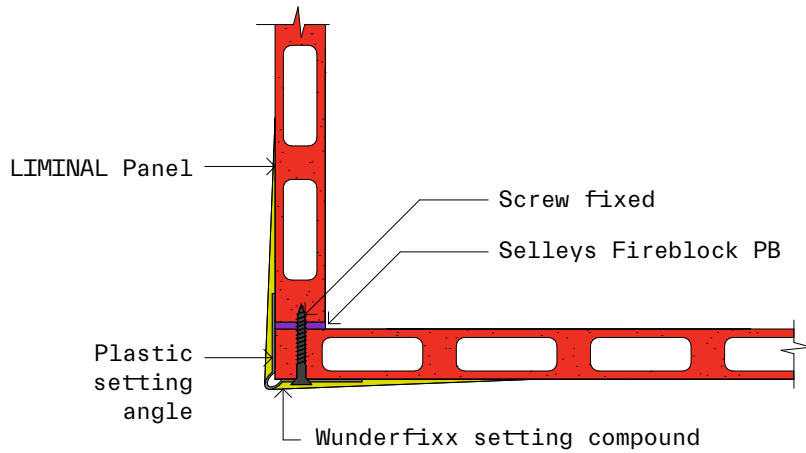

Control Joint - Liminal Express, Groove (Option 2 & 3)

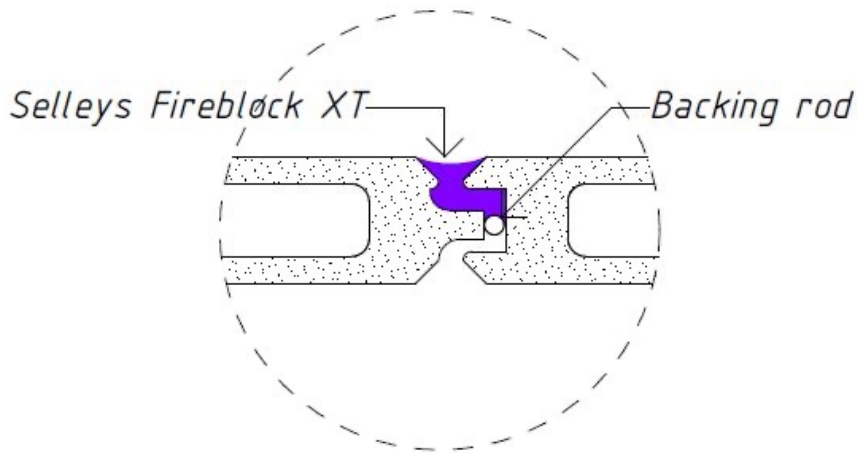

Control Joint - Liminal Smooth (Option 2 & 3)

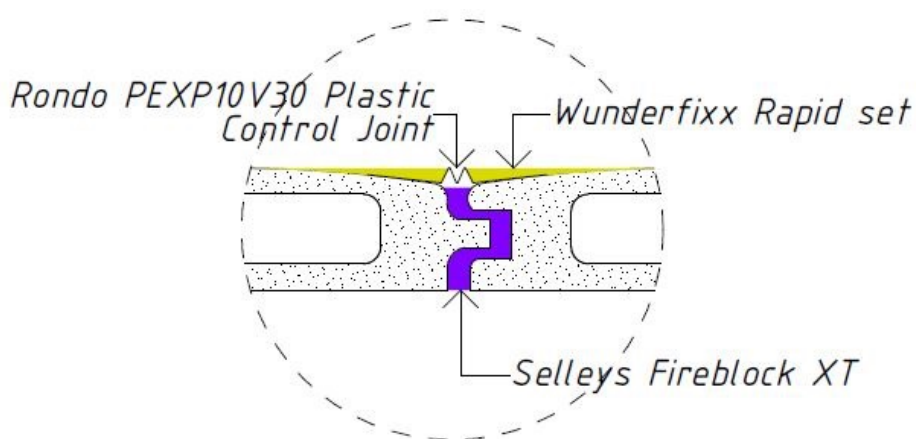

Gluing the Liminal Smooth panel joints

Measure the panel to the correct length and width then apply a minimum of a 10mm bead of Selleys Fireblock PB to the groove of the panel for installation. Putting the caulking compound in the groove makes for cleaner handling of the panel into its final position. Push the panels together so the Selleys Fireblock PB is expressed then apply the fibreglass tape into the expressed compound then wiping the excess off in preparation for the setting compounds

Gluing the Architectural designed panel joints

Like the Liminal Smooth measure and cut the panel to the correct length and width then apply a maximum of a 10mm bead of Selleys Fireblock PB. Push the panels together making sure the Selleys Fireblock PB is NOT expressed. If there is some that is expressed promptly clean and wipe with the cleaning agents.

Important to note, that all rigid joints are glued together with Selleys Fire Block PB and all control joints must use Selleys Fire Block XT.

Setting the panels

Liminal wall recommends the use of Wunderfixx Rapid Set to set the recessed joints, countersunk screw fixing and patching. If the fibreglass tape has not already been installed in the Selleys Fireblock PB then apply the first coat of the Wunderfixx Rapid Set to the recessed joint, then apply the fibreglass tape ensuring the joint is full and clean. Allow 24hours for the Wunderfixx to dry then apply the second coat of Wunderfixx Rapid Set, allow to dry then sand smooth within 48 hours to be ready for paint.

Liminal Panel Control Joints Settings

Horizontal Control Joint

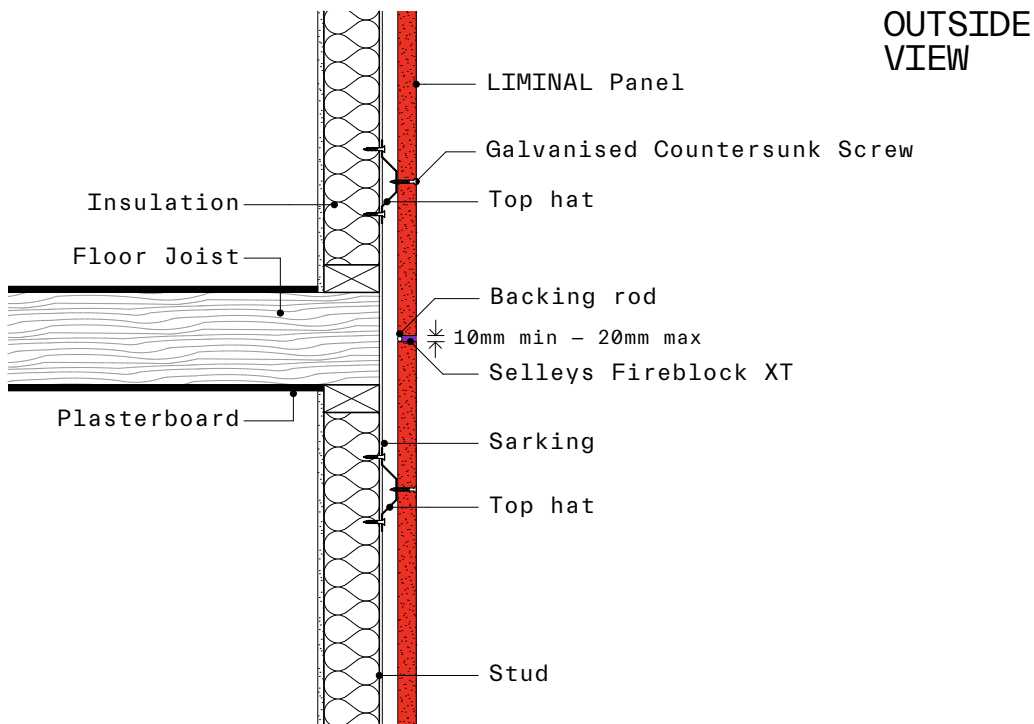

Window Control Joint

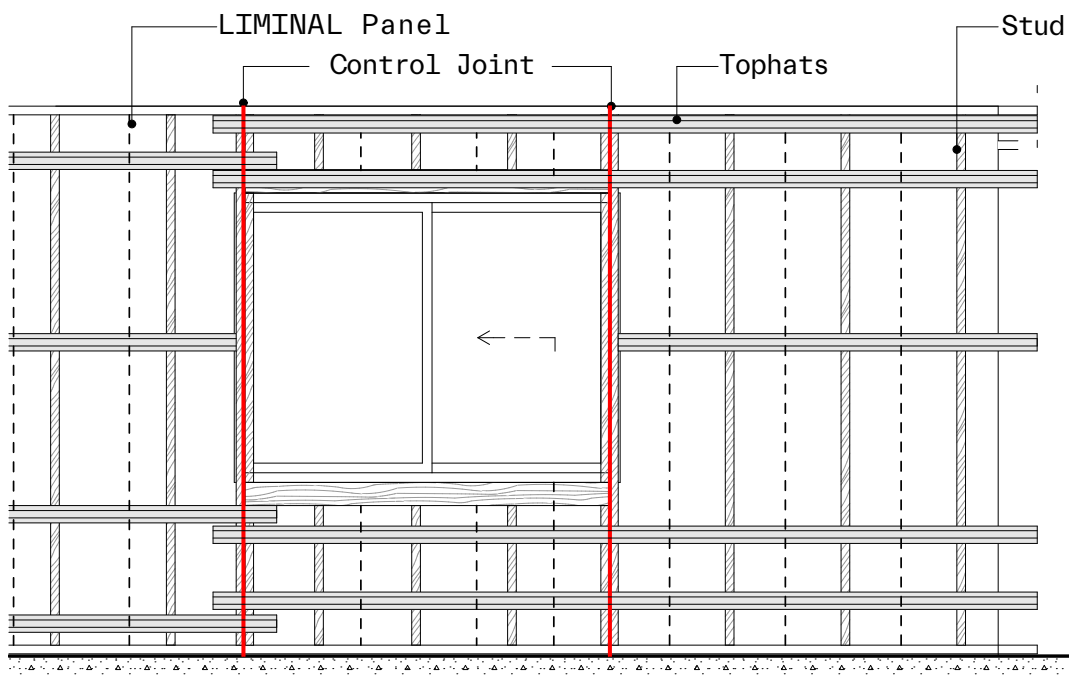

Liminal Panel Window Details

Option 1 - Head & Sills

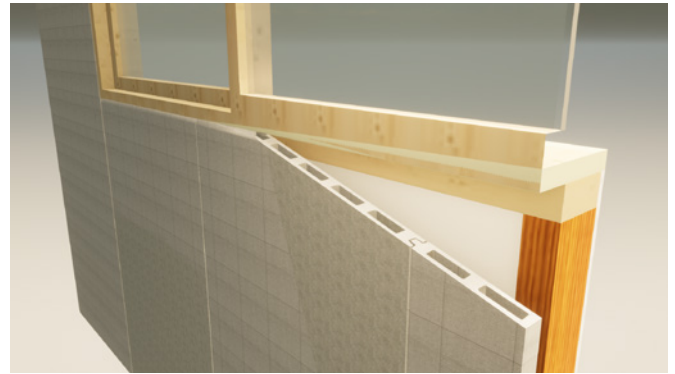
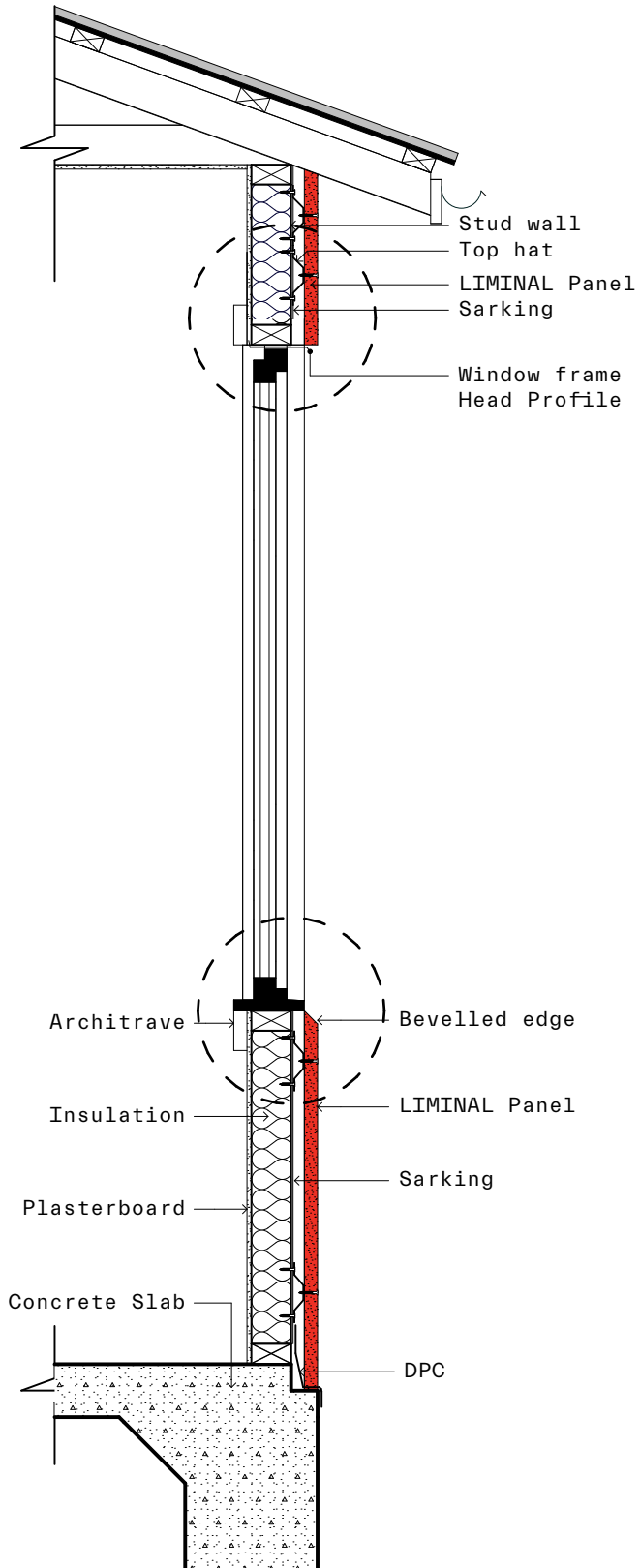

Head - Option 1

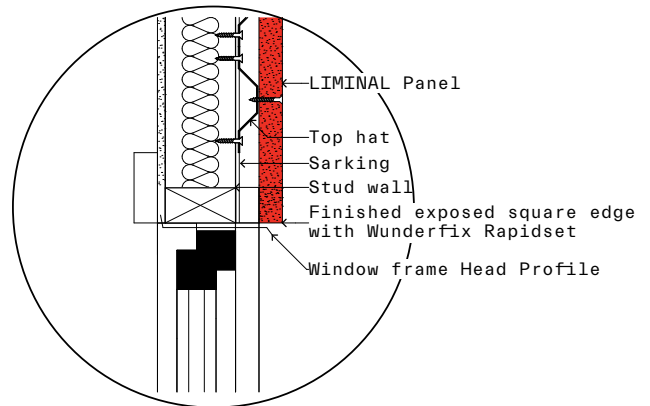

Sill - Option 1

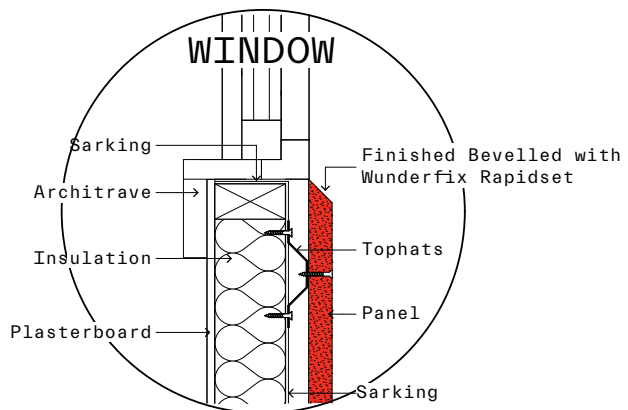

Liminal Panel Window Details

Option 2 - Head & Sills

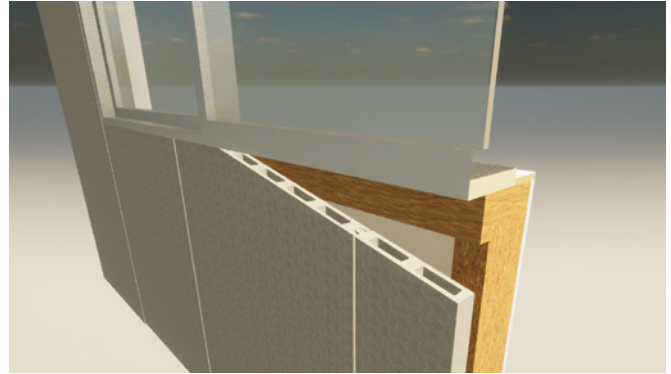
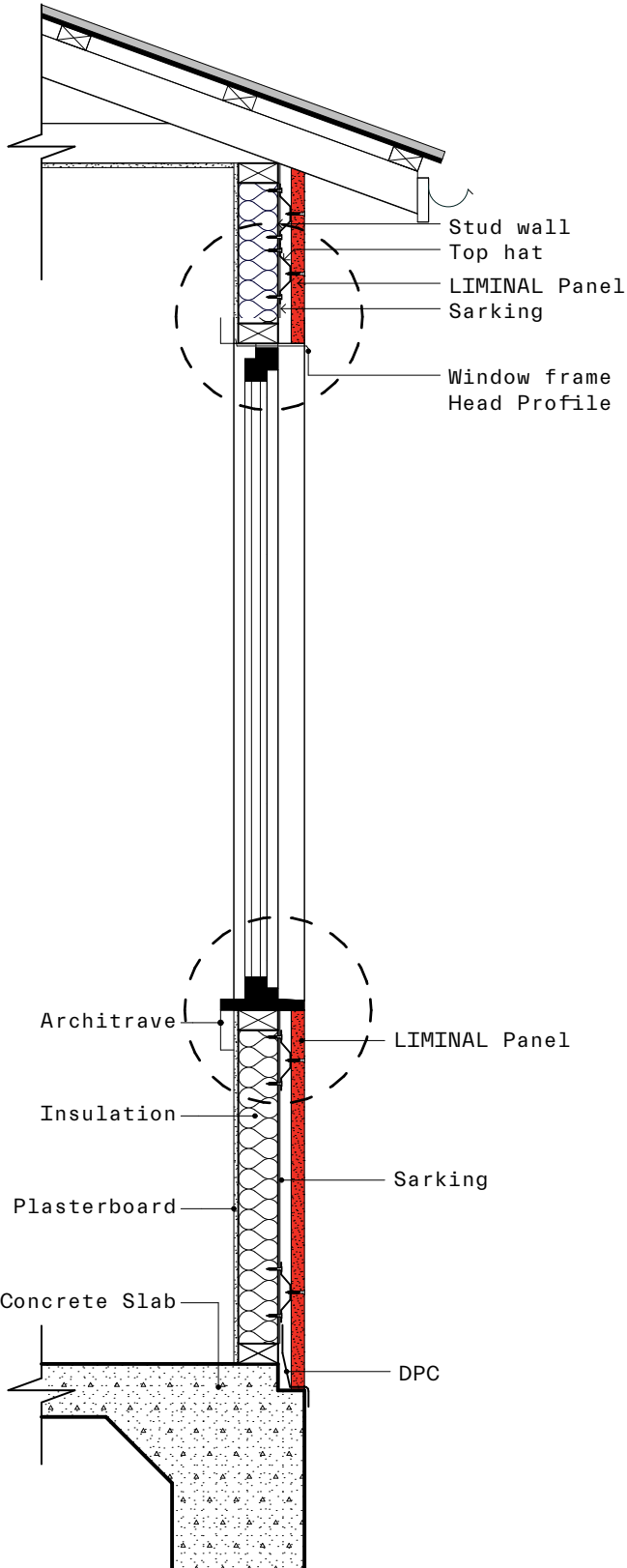

Head - Option 2

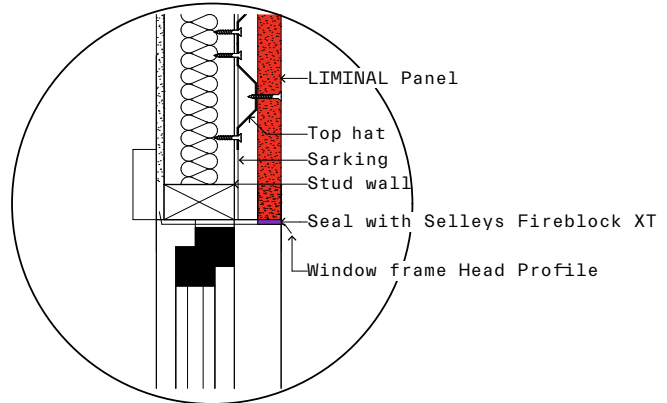

Sill - Option 2

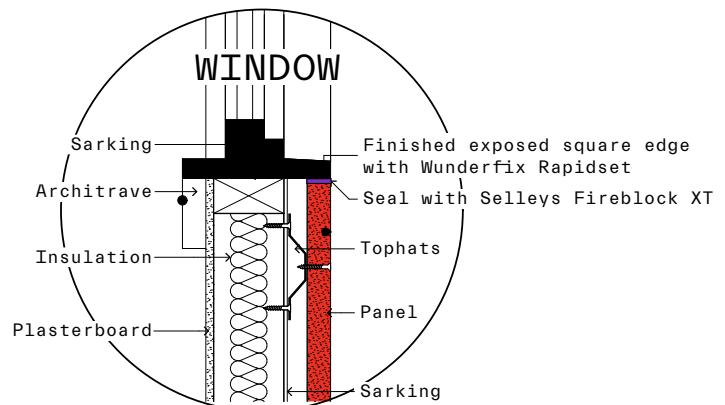

Liminal Panel Window Details

Option 3 - Head & Sills

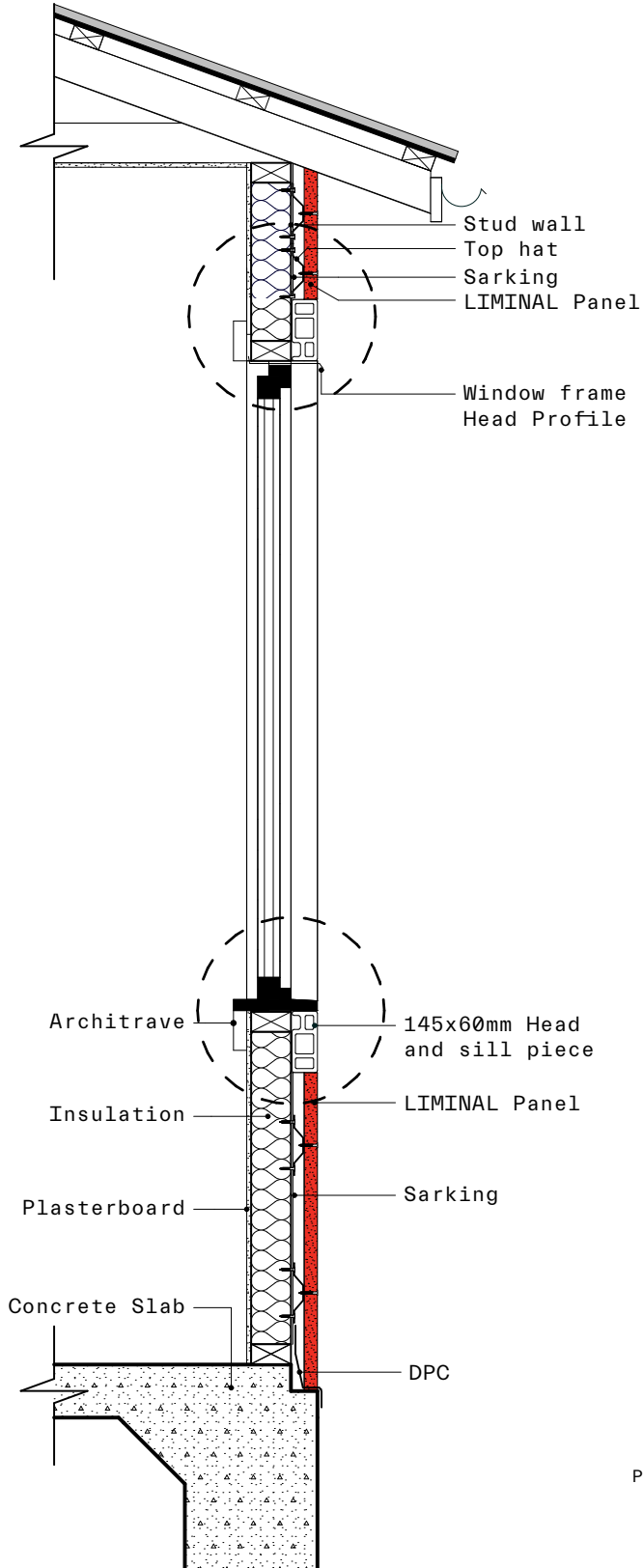

Head - Option 3

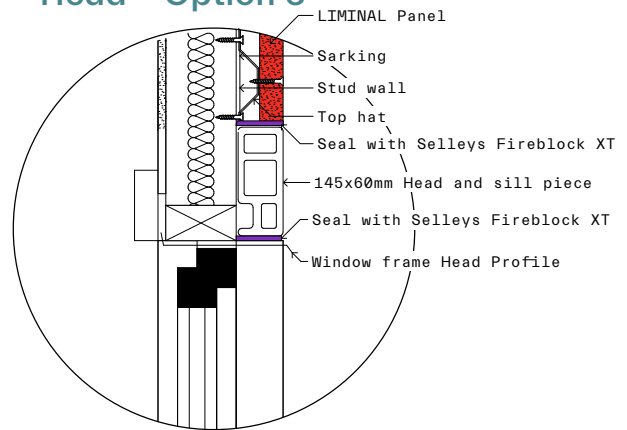

Sill - Option 3

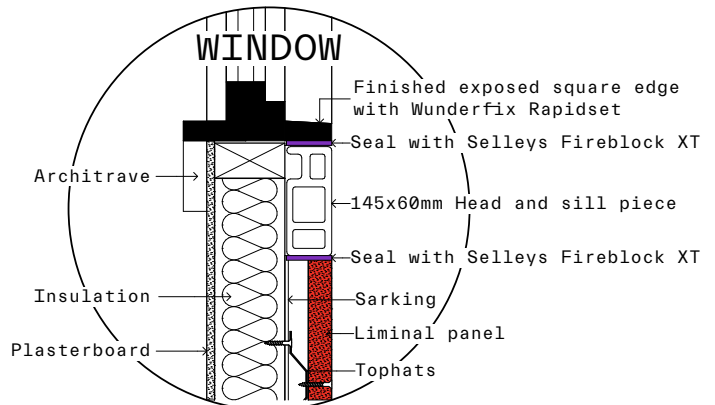

Liminal Panel Corner Details

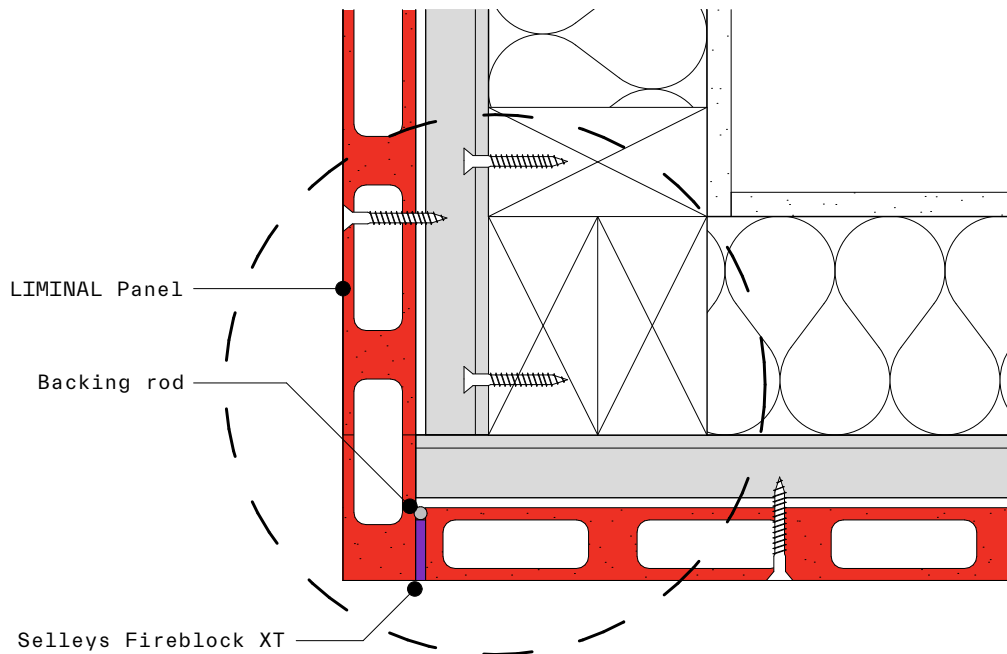

Corner Setting with Liminal Trim

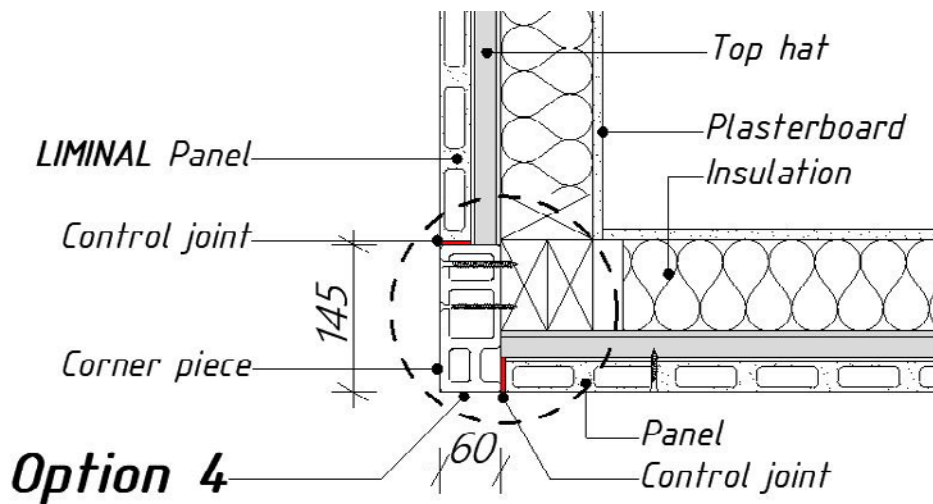

Installation

- 1 Structural frames are installed, and sarking completed
- 2 Set out panel configuration and note locations of control joints
- 3 Install DPC, overlapping joints
- 4 Measure and set out the top hat locations based on above tables
- 5 Ensure top hats are discontinuous at all control joints
- 6 Install the first panel, measure and cut to size
 - a Start at the corner, remove the tongue so the corner is square
 - b Screw fixes the panel to the top hat using the screws in the above table
 - c Apply the caulking compound to the groove of the installed panel
 - d Install next panel and repeat
 - e Check the control joints are in the correct location and the top hats are discontinuous
 - f Rebate cut panel edges where required for setting.
 - g Measure panels to be fixed around windows and doors and cut panels.
 - h All window and door openings must have a control joint on at least 1 side of the opening

Tools

The Liminal panel is a cement extruded panel with a strength of 40MPa. It's recommend all cutting tools/blades to be diamond tipped.

- 1 Power saw with diamond tipped blade to cut the panels
- 2 Cordless angle grinder to cut the top hats
- 3 Cordless impact drill or auto feed screw driving screw system to fix panels to top hats
- 4 Power rebating tool
- 5 Power caulking gun to apply the caulking compound
- 6 Laser level
- 7 Class M or L vacuum for all cutting

OH&S

Personal Protection Equipment (PPE) is recommended to protect eyes, skin, ears, and respiration while working with the Liminal Panel.

Employers are responsible for providing appropriate personal protection equipment.

- A disposable P1 or P2 dust mask must be worn at all times.
- We recommend wearing gloves to avoid skin abrasion and irritation.
- Wear eye and ear protection.

Cutting

The Liminal Panel product is manufactured from concrete material. Fine dust may be present on the supplied panel from time of manufacture or generated during working with the panel cutting, drilling, grinding, breaking, sawing, and finishing.

Handling

The Liminal Panel products shall be bundled and strapped to pallets or gluts to ensure the panels are clear off the ground and evenly supported. The panel bundles can be wrapped in plastic to secure any loose panel pieces caused by damage.

A Safety Data Sheet shall be included inside the plastic wrap of every panel bundle.

The use of approved lifting equipment is recommended when moving the panels in the work area and throughout installation.

Storage

The Liminal Panel products are to be stored in a dry area, clear off the ground and in areas which minimise the chance of damage.

SDS

Additional information is presented in the Safety Data Sheet. Document number LW- SDS - 001-FEB 2022 Version: 1.0 located on our website www.liminalwall.com.au, or by request.

Product Technical Statement

Please refer to the Liminal Product technical statement which can be located on our website www.liminalwall.com.au, or by request.

Disclaimers and Warranty

Please refer to the Liminal Wall Systems General Terms and conditions of Trade document which can be located on our website www.liminalwall.com.au, or by request.

Liminal Wall Systems Pty Ltd
ABN 22 646 545 137

sales@liminalwall.com.au
liminalwall.com.au

TM

ORIGINAL